

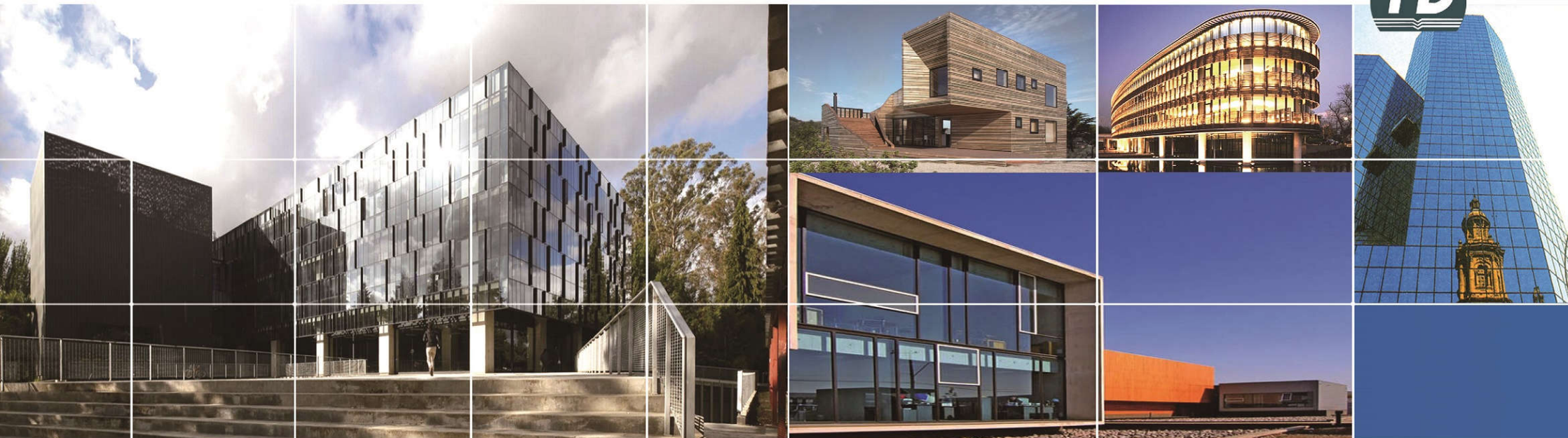

SHANDONG SAINTY ALUMINIUM LIMITED  
www.staluminum.com



China Main office located at Our factory  
Address : Sainty Road NO.88, Taizhou City, Jiangsu Province,  
Phone : +86 523 89700181 Fax : +86 523 89700181  
Mobile : +86 150 5290 5768(12\*7)  
E-mail : info@staluminum.com (For Pre-sale)  
E-mail : sophia@staluminum.com (For In-Sale)  
E-mail : richard@staluminum.com (For After-Sale)  
Middle East office located at Teheran  
Address : Unit 1001 Fourseas Building 208-212 ,Teheran,Iran.  
Tel-Iran: + 98 21 7711 7593  
E-mail : iran@staluminum.com (For Pre-sale)  
South America Office in Bolivia  
Tel-Bolivia: +591-2-2944519  
E-mail : info@staluminum.com (For Pre-sale)  
Sale Office in Africa  
Tel-Africa: +22 07903495  
E-mail : info@staluminum.com (For Pre-sale)

Foldable Door

Hang Door

High Rise Railing



HIGH RISE ALUMINIUM WINDOW SERIES SOLUTION

# MATERIAL

## ■ ALLOYS

### ● Alloy Composition

Aluminum Grade	Si	Fe	Cu	Mn	Mg	Cr	Zn	Ti	Impurity	Al
6063	0.2-0.6	<0.35	<0.1	<0.1	0.45-0.9	<0.1	<0.1	<0.1	<0.15	Rest
6063A	0.3-0.6	0.15-0.35	<0.1	<0.1	0.6-0.9	<0.05	<0.15	<0.1	<0.15	Rest
6061	0.4-0.8	0.7	0.15-0.4	<0.15	0.8-1.2	0.04-0.35	<0.25	<0.15	<0.15	Rest
LTF21	<0.6	<0.7	<0.2	1.0-1.5	<0.05		<0.1	<0.15	<0.1	Rest
6005	0.6-0.9	<0.35	<0.1	<0.1	0.4-0.9	0.1	<0.1	<0.1	<0.15	Rest

### ● Typical mechanical properties for aluminum profile

Aluminum Grade	Temper	Wall Thickness	Resist Pull Point(Mpa)	Stretch (Rpo.2 Mpa)	Stretch Rate	Webster Hardness
6063	T5	All	160	110	8	8
	T6	All	205	180	8	
6063A	T5	=<10	200	160	5	10
	T6	>10	230	190	5	
6061	T4	All	180	110	16	
	T6	All	265	245	8	
LTF21	O,H112	All	=<185	260	16	
6005	T5	=<3.2	260	240	8	
		>3.2-25	260	240	10	

QC Team Trained By SGS Process

# MATERIAL

## ■ PERFORMANCE

- Anodized Surface Colors (Silver, Black, Champagne, Bronze,Gold)

Alloy Grade	Standard	Thickness(μm)	Corrosion Resistance	Abrasive Resistance
6063/6061 6060/6463	GB5237	AA10,AA,15, AA20,AA25	≥9	≥300

- Powder Coated Surface Colors (RAL Code based)

Alloy Grade	Standard	Thickness(μm)	Corrosion Resistance	Abrasive Resistance
6063/6061 6060/6463	GB5237-2011	≥40	≥9.5	A≥3300 B≥3000 C≥2400

- Polishing Surface colors(Mirror, Black, Champagne, Bronze, Gold)

### Alloy Corresponds to the following standard designations and specifications

AA6063	Al Mg0.7Si
GS10	AlMgSi0.5
A-GS	3.32206
ASTM B210	ASTM B221
ASTM B241 (Pipe- Seamless)	ASTM B345 (Pipe- Seamless)
ASTM B361	ASTM B429
ASTM B483	ASTM B491
MIL G-18014	MIL G-18015
MIL P-25995	MIL W-85
QQ A-200/9	SAE J454

Test Hardness,Flatness,Twist,Color Thickness,Assembling For Each Lot Cargo



# EXTRUDE

## ■ EQUIPMENT



35 Extruded Production  
Italy Vertical Powder coating  
12 Different Anodised Colour  
Moulds over for 30 countries

SGS Certificated  
ISO9001 Certificated



# PROFESSIONAL

## ■ CNC MACHINING

45,90 Degree Cutting  
Drilling Holes  
Stamping Holes  
Tapping screw holes  
Polishing surface  
Colouring after machining



Solar Frame Cutting And produce  
Ladder Frame Cutting





# FACTORY SHOW

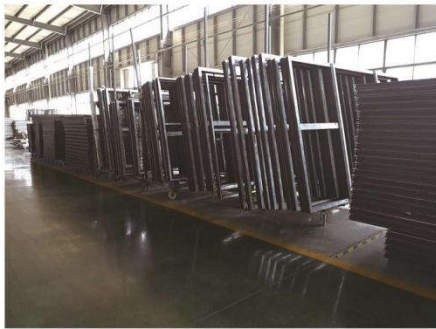

# GLASS&ACCORRIESS

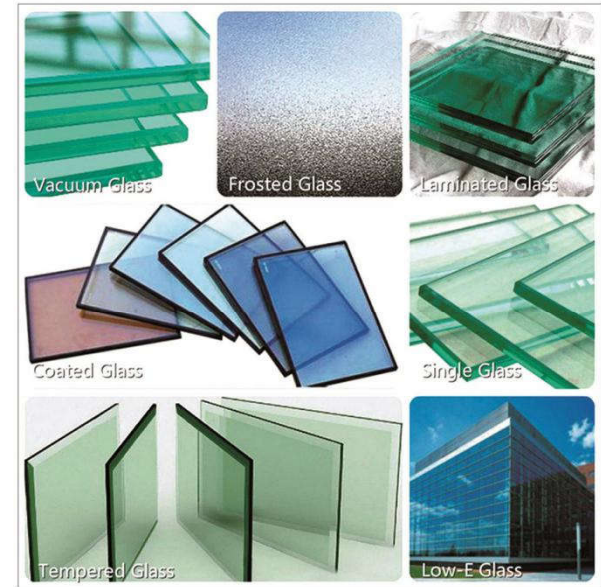



# WINDOW&DOOR DESIGNS PART 1



Sliding window



Casement window(50-70-100)



Folding window



Hanging window



Swing window



Folding door



Kitchen hanging window



Kitchen sliding door



Integrated doors and windows



Integrated curtain wall and windows



Commercial storefront



Integrated curtain wall and door

# WINDOW&DOOR DESIGNS PART 2



Window with screen



Door with screen



Double glass door with louvers inside



Fixed shutter



Balcony railing



Wood aluminum series



Aluminum sunroom for swimming pool



The Long Corridor



Sky window



Window with louver



The curtain wall



Topless Glass Deck Railing



# Designs

## ■ CATALOGUE

- 1、 Company Introduction
- 2、 Extrude Equipment Details
- 3、 CNC Machining Details
- 4、 Material Alloy,Standards
- 5、 Material Performance
- 6、 Hang Door Series ..... Page1~Page 4
- 7、 Foldable Door 90 Series ..... Page5~Page 11
- 8、 Foldable Door 60 Series ..... Page12~Page 16
- 9、 Partition Series ..... Page 17~Page 24
- 10、 High Rise Window Series ..... Page 25~Page 29
- 11、 High Rise Railing Series ..... Page 30~Page 33
- 12、 Curtain Wall Series ..... Page 34~Page 45

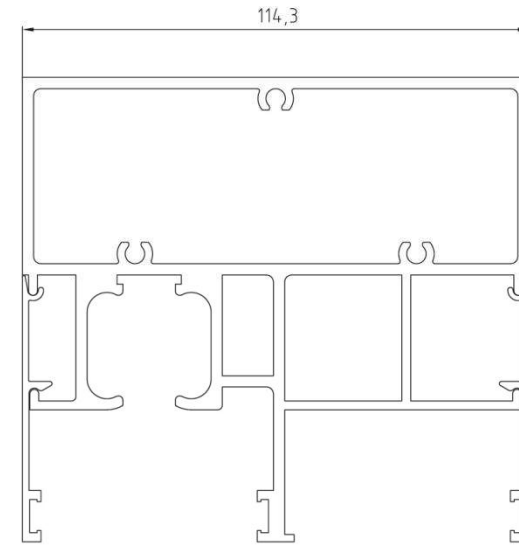
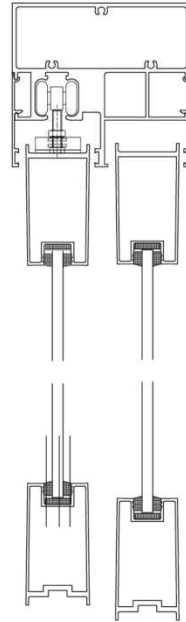
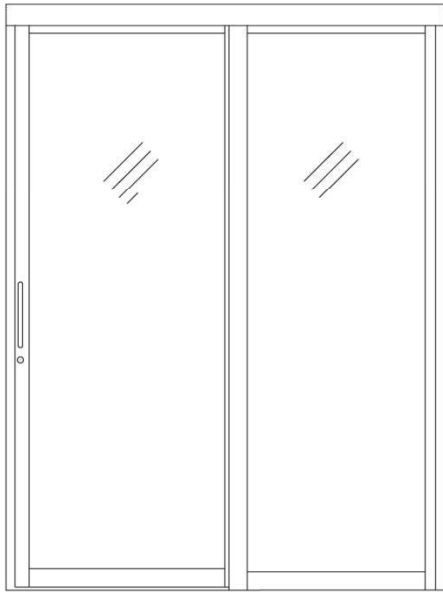

Dwg NO.	Thickness (mm)	Weight (kg/m)
F090	2.55	4.192

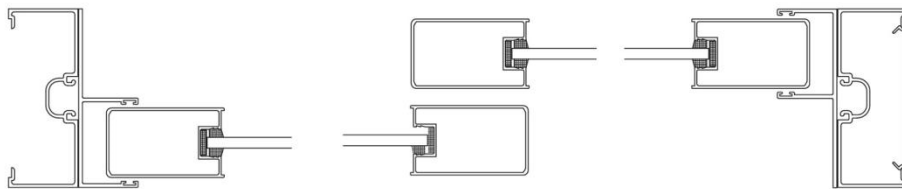

Dwg NO.	Thickness (mm)	Weight (kg/m)
F092A	1.5	1.398

Dwg NO.	Thickness (mm)	Weight (kg/m)
F092	1.5	1.4



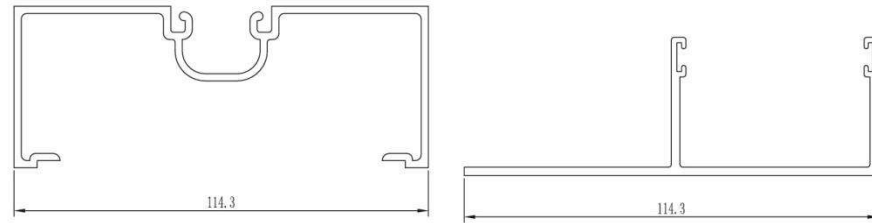

Dwg NO.	Thickness (mm)	Weight (kg/m)	Dwg NO.	Thickness (mm)	Weight (kg/m)
F087	2.0	1.464	F086	2.35	1.193

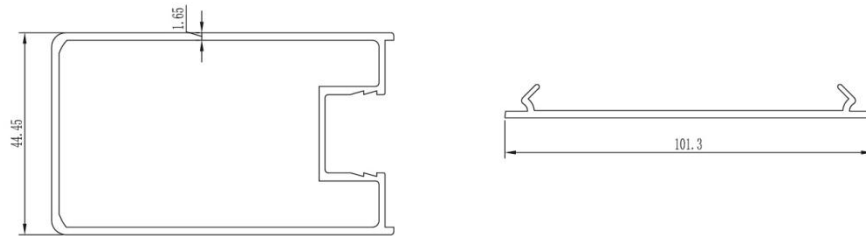

Dwg NO.	Thickness (mm)	Weight (kg/m)	Dwg NO.	Thickness (mm)	Weight (kg/m)
F089	1.65	1.314	F088	1.0	0.756

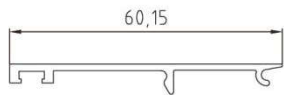

Dwg NO.	Thickness (mm)	Weight (kg/m)
F093	1.5	0.306



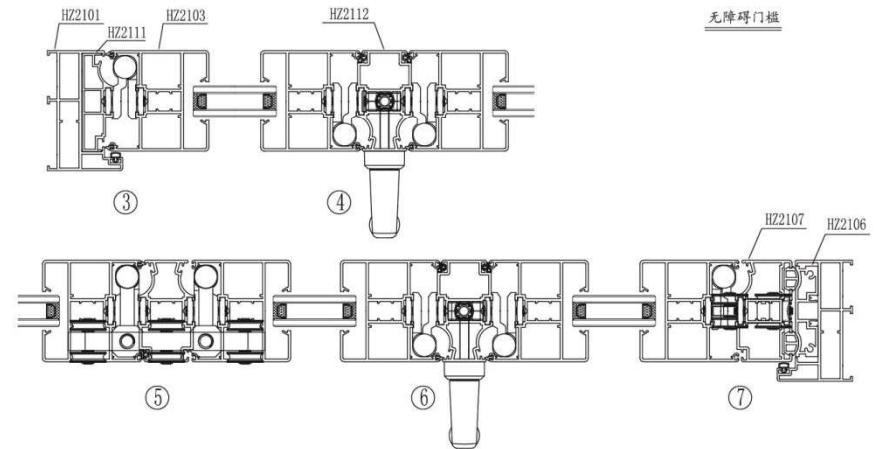
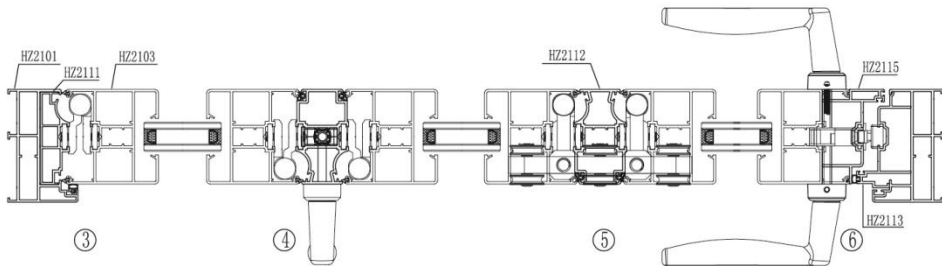
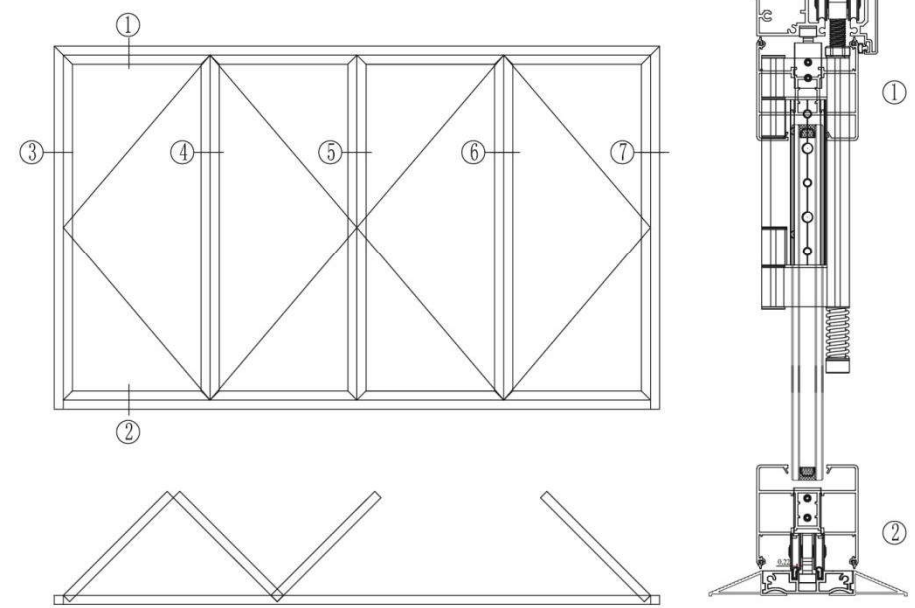
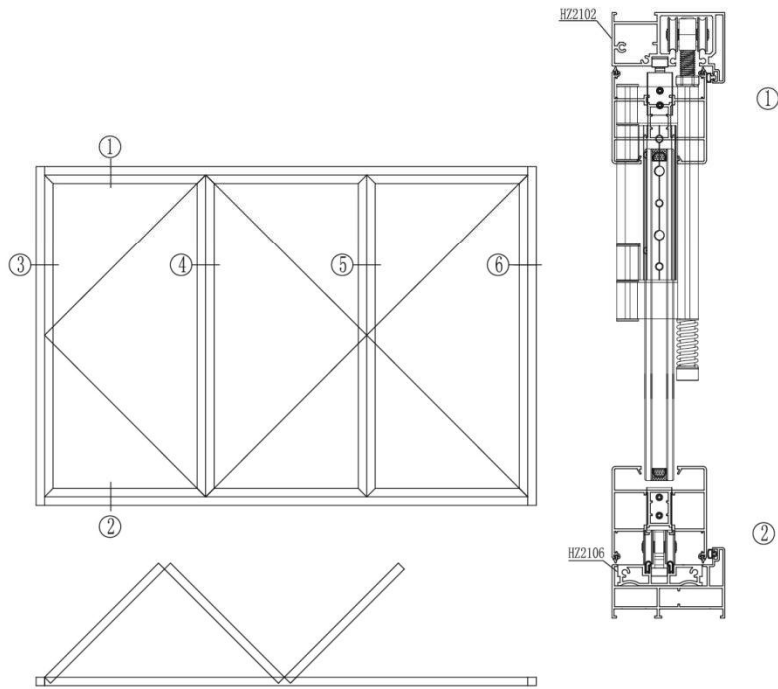



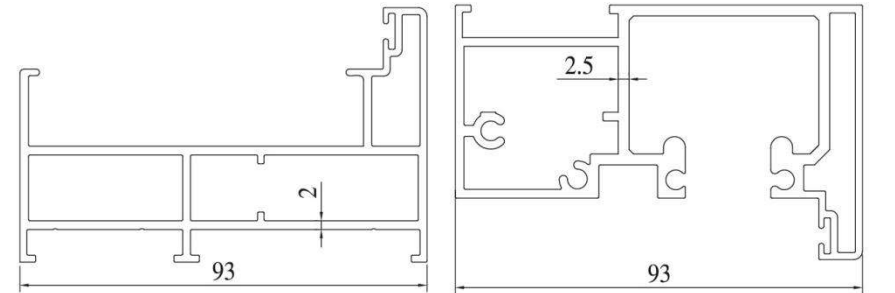
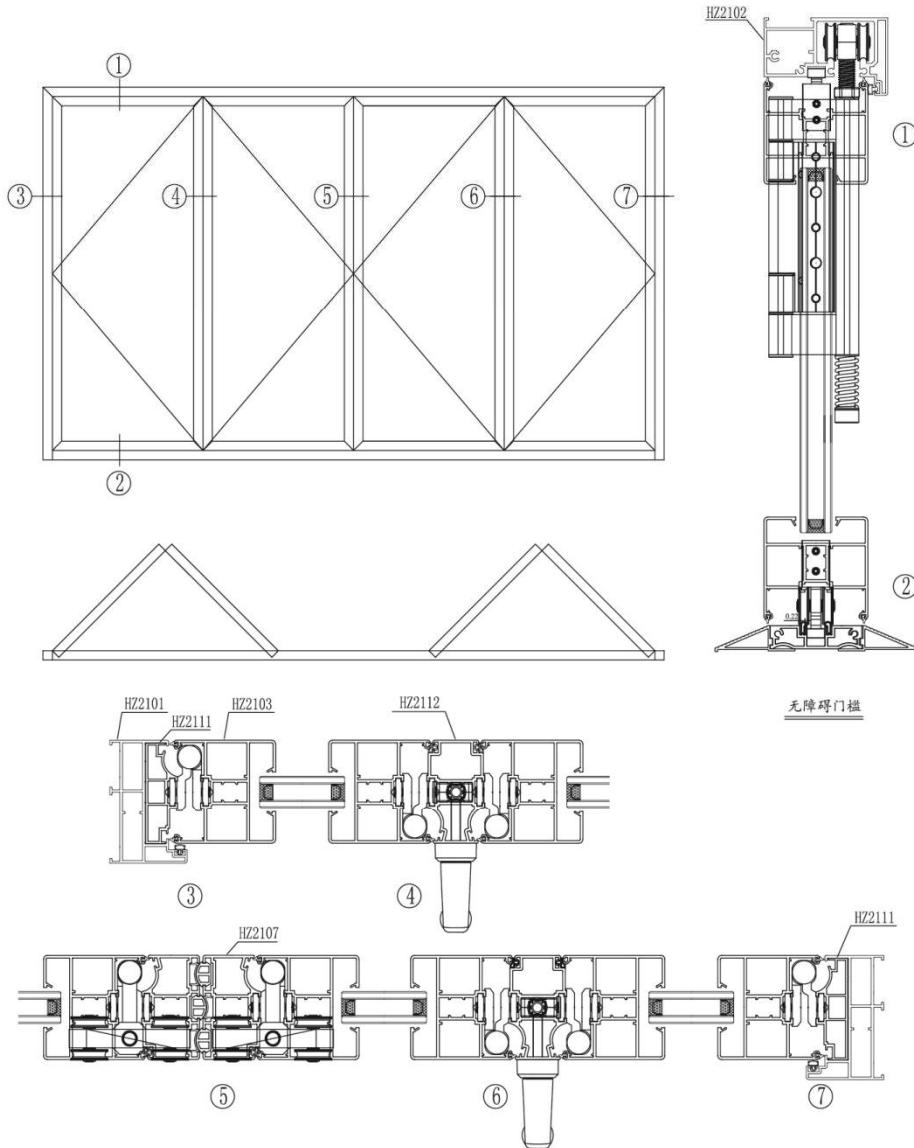

Dwg NO.	Thickness (mm)	Weight (kg/m)
HZ2101	2.0	1.871

Dwg NO.	Thickness (mm)	Weight (kg/m)
HZ2102	2.5	2.484

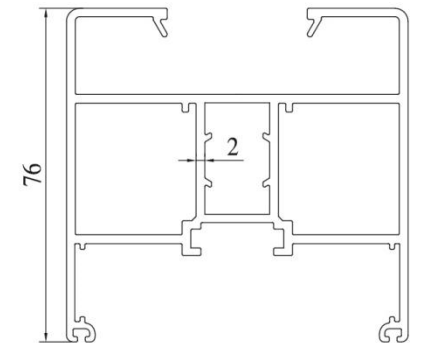

Dwg NO.	Thickness (mm)	Weight (kg/m)
HZ2103	2.0	2.328

Dwg NO.	Thickness (mm)	Weight (kg/m)
HZ2104	2.0	2.159

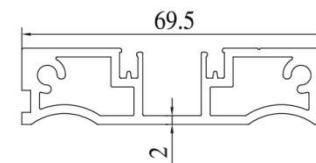

Dwg NO.	Thickness (mm)	Weight (kg/m)
HZ2106	2.0	1.217

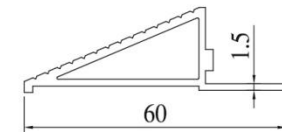

Dwg NO.	Thickness (mm)	Weight (kg/m)
HZ2108	1.5	0.549

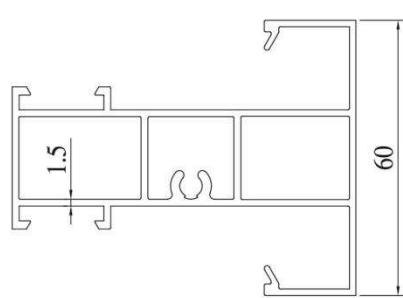

Dwg NO.	Thickness (mm)	Weight (kg/m)
HZ2105	1.5	1.411

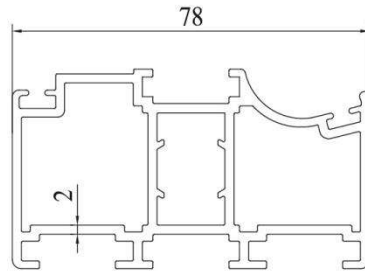

Dwg NO.	Thickness (mm)	Weight (kg/m)
HZ2107	2.0	1.896

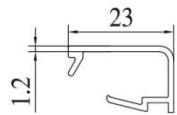

Dwg NO.	Thickness (mm)	Weight (kg/m)
HZ2109	1.2	0.191

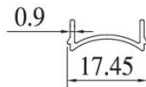

Dwg NO.	Thickness (mm)	Weight (kg/m)
HZ2110	0.9	0.073

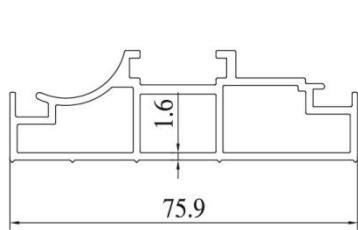

Dwg NO.	Thickness (mm)	Weight (kg/m)
HZ2111	1.6	1.055

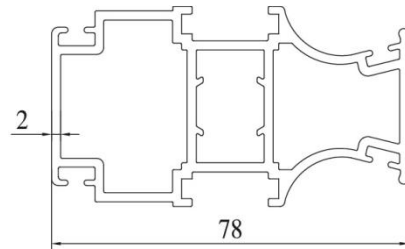

Dwg NO.	Thickness (mm)	Weight (kg/m)
HZ2112	2.0	1.821

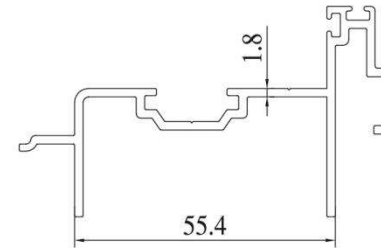

Dwg NO.	Thickness (mm)	Weight (kg/m)
HZ2113	1.8	0.938

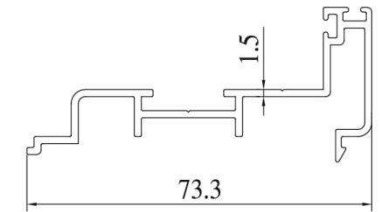

Dwg NO.	Thickness (mm)	Weight (kg/m)
HZ2114	1.5	0.668

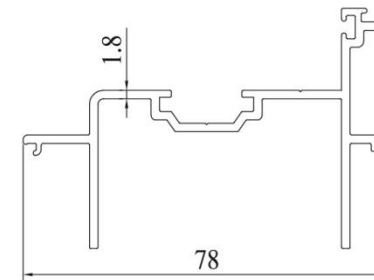

Dwg NO.	Thickness (mm)	Weight (kg/m)
HZ2115	1.8	1.039

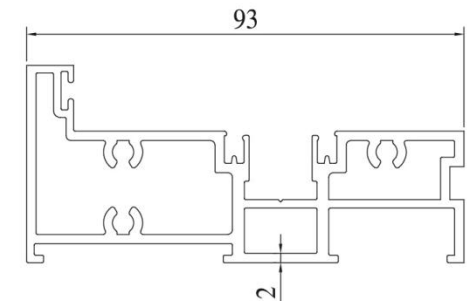

Dwg NO.	Thickness (mm)	Weight (kg/m)
HZ2117	2.0	2.008

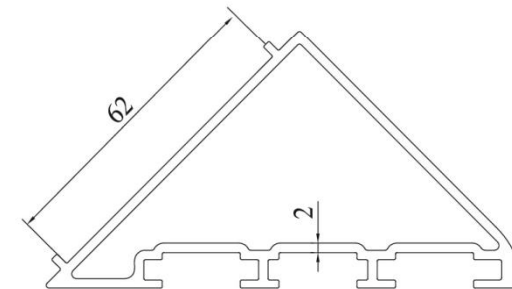

Dwg NO.	Thickness (mm)	Weight (kg/m)
HZ2116	2.0	1.601





China Famous Brand  
www.staluminum.com



Foldable Door 90 Series



25-Years Professional Supplier  
Export to more than 30 countries

11

TEL/WhatsApp/WeChat: +86 150 5290 5768  
Email: info@staluminum.com



China Famous Brand  
www.staluminum.com



Foldable Door 60 Series

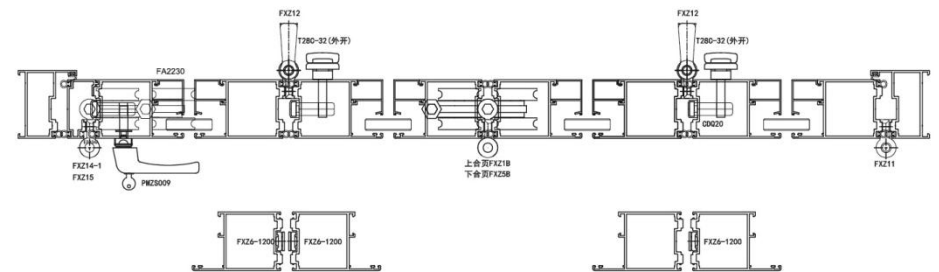
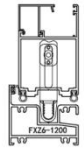
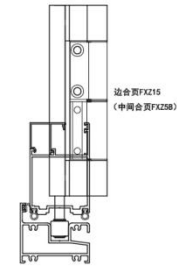
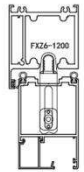
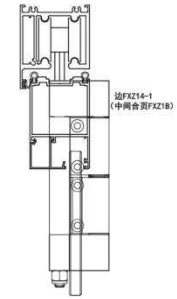
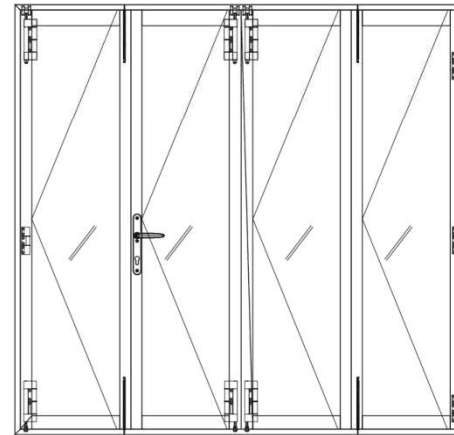

25-Years Professional Supplier  
Export to more than 30 countries

12

TEL/WhatsApp/WeChat: +86 150 5290 5768  
Email: info@staluminum.com

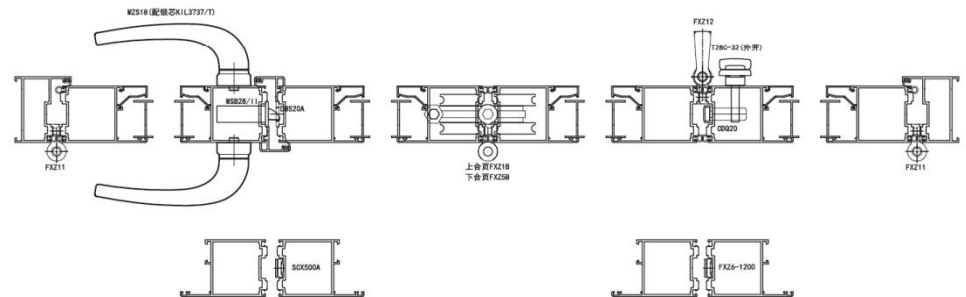
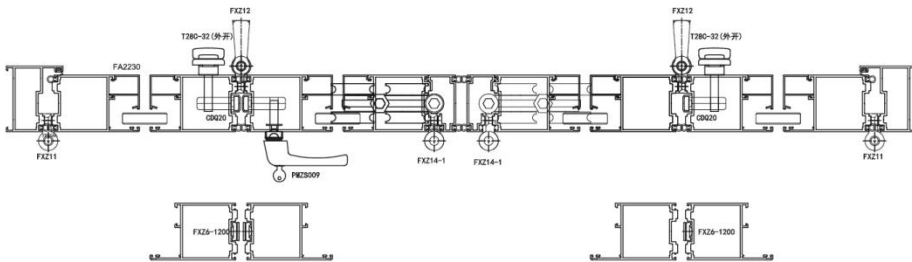
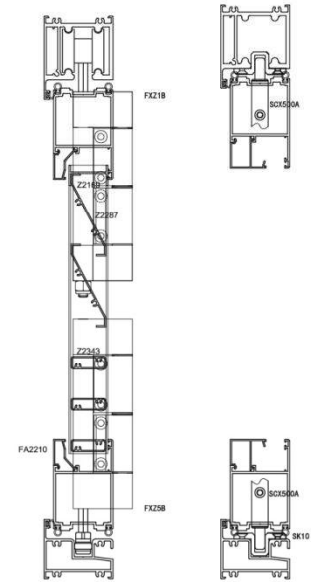
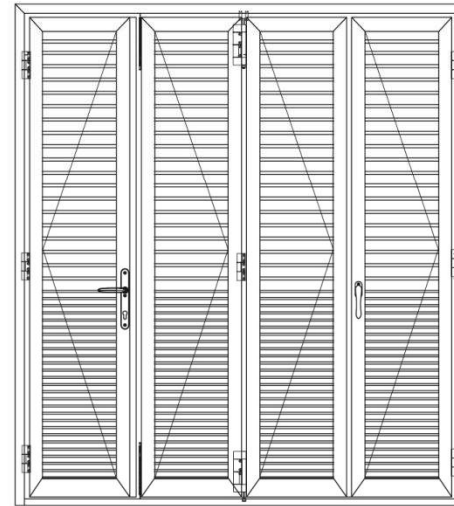
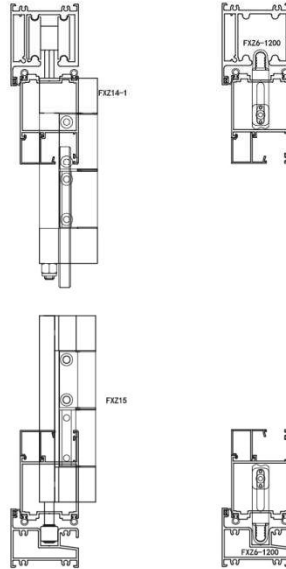
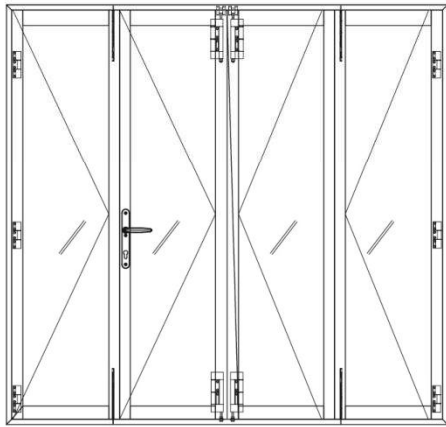



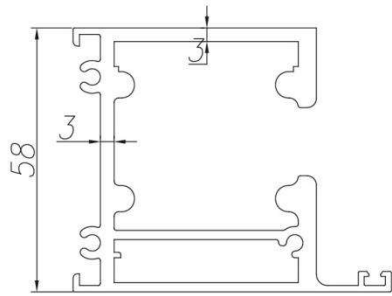

Dwg NO.	Thickness (mm)	Weight (kg/m)
ZD6000	3.0	2.235

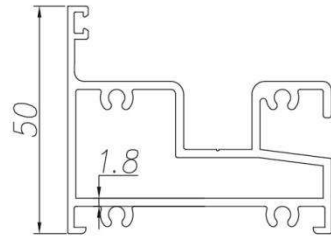

Dwg NO.	Thickness (mm)	Weight (kg/m)
ZD6001	1.8	1.309

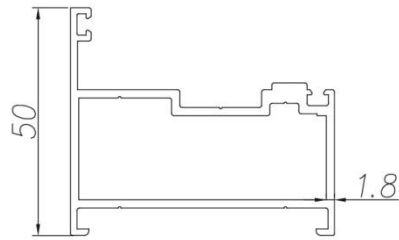

Dwg NO.	Thickness (mm)	Weight (kg/m)
ZD6002	1.8	1.055

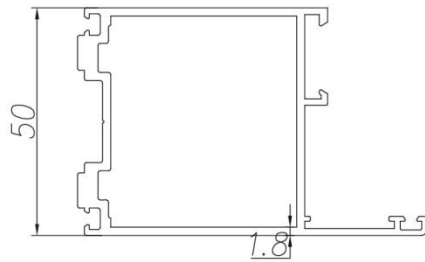

Dwg NO.	Thickness (mm)	Weight (kg/m)
ZD6003	1.8	1.303

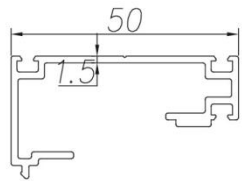

Dwg NO.	Thickness (mm)	Weight (kg/m)
ZD6004	1.5	0.551

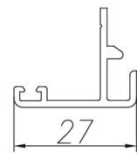

Dwg NO.	Thickness (mm)	Weight (kg/m)
ZD6005	1.5	0.261



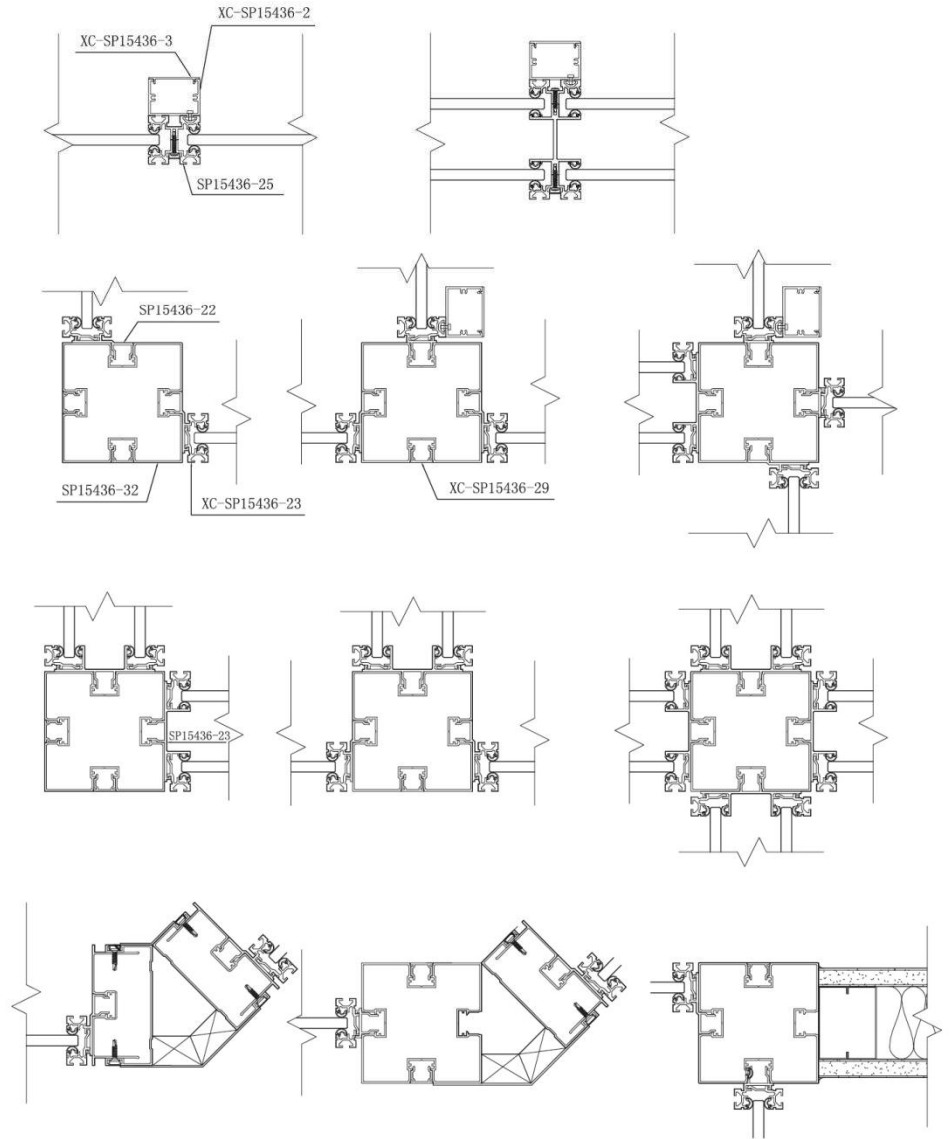
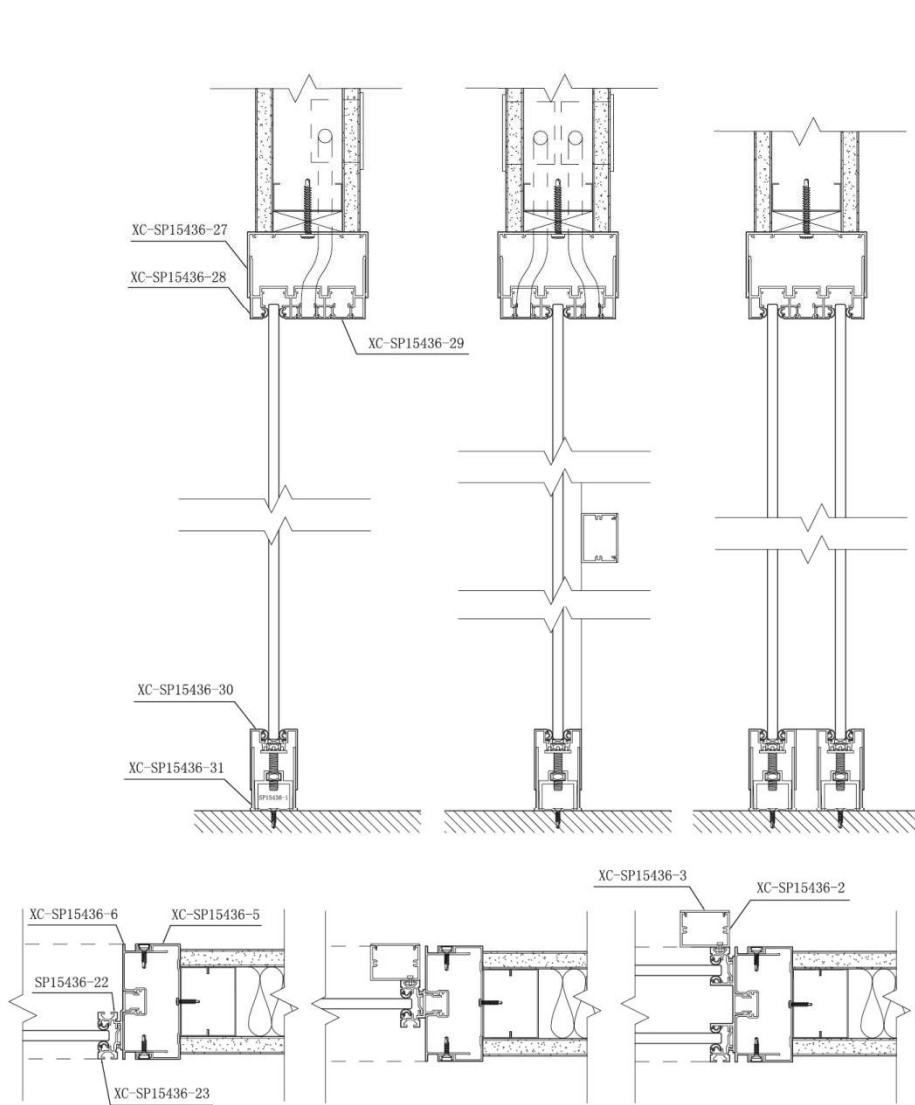



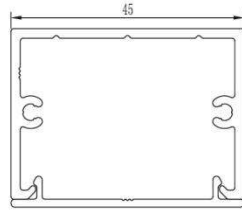
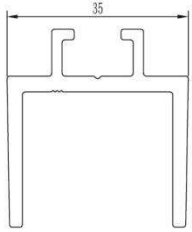

Dwg NO.	Thickness (mm)	Weight (kg/m)
SP15436-1	3.0	0.77

Dwg NO.	Thickness (mm)	Weight (kg/m)
SP15436-2	1.8	0.61

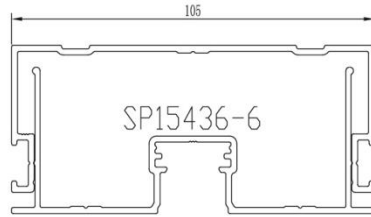
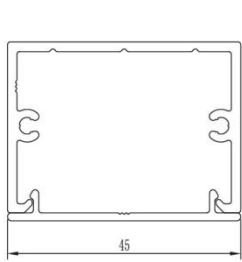

Dwg NO.	Thickness (mm)	Weight (kg/m)
SP15436-3	1.5	0.2

Dwg NO.	Thickness (mm)	Weight (kg/m)
SP15436-5	1.7	0.97

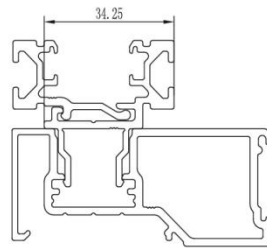
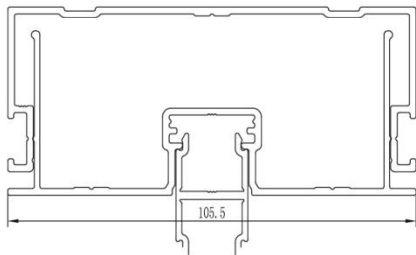

Dwg NO.	Thickness (mm)	Weight (kg/m)
SP15436-6	1.7	1.04

Dwg NO.	Thickness (mm)	Weight (kg/m)
SP15436-21	1.7	0.306

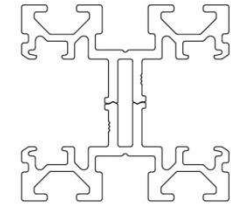
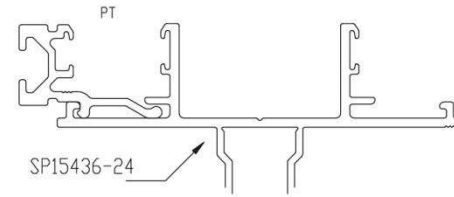

Dwg NO.	Thickness (mm)	Weight (kg/m)
SP15436-23		0.372

Dwg NO.	Thickness (mm)	Weight (kg/m)
SP15436-25	2.35	0.683

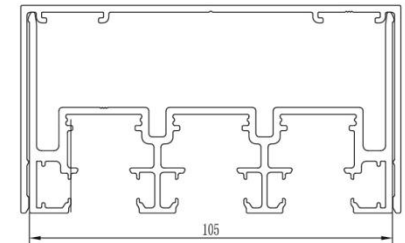
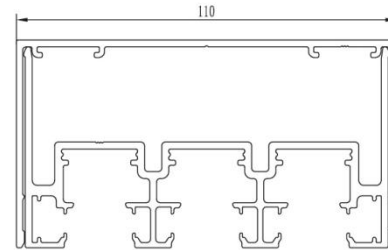

Dwg NO.	Thickness (mm)	Weight (kg/m)
SP15436-27	1.6	1.24

Dwg NO.	Thickness (mm)	Weight (kg/m)
SP15436-28	2.0	2.22

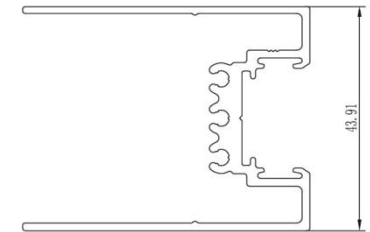
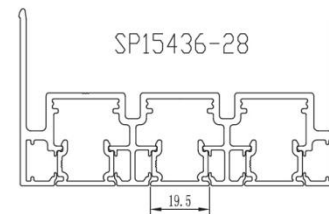

Dwg NO.	Thickness (mm)	Weight (kg/m)
SP15436-29	1.5	0.21

Dwg NO.	Thickness (mm)	Weight (kg/m)
SP15436-30	1.5	0.97

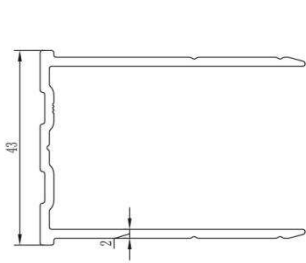

Dwg NO.	Thickness (mm)	Weight (kg/m)
SP15436-31	2.0	0.85

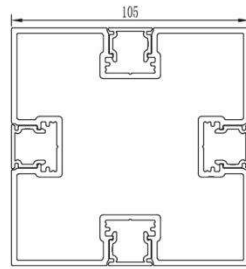

Dwg NO.	Thickness (mm)	Weight (kg/m)
SP15436-32	2.4	3.96

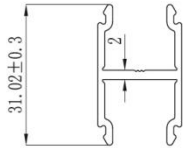

Dwg NO.	Thickness (mm)	Weight (kg/m)
SP15436-4	2.0	0.356

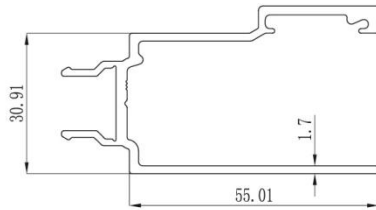

Dwg NO.	Thickness (mm)	Weight (kg/m)
SP15436-7	1.7	0.898

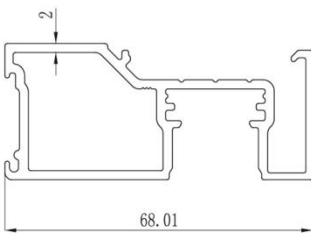

Dwg NO.	Thickness (mm)	Weight (kg/m)
SP15436-8	2.0	1.119

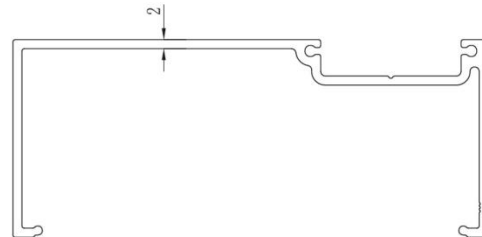

Dwg NO.	Thickness (mm)	Weight (kg/m)
SP15436-9	2.0	1.153

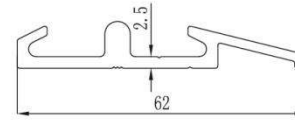

Dwg NO.	Thickness (mm)	Weight (kg/m)
SP15436-10	2.5	0.623

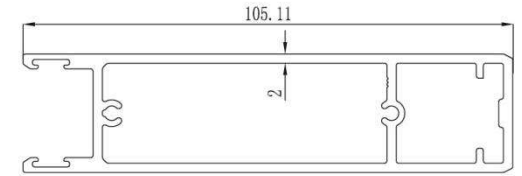

Dwg NO.	Thickness (mm)	Weight (kg/m)
SP15436-12	2.0	1.58

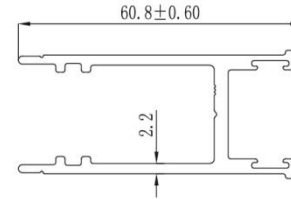

Dwg NO.	Thickness (mm)	Weight (kg/m)
SP15436-13	2.2	0.906

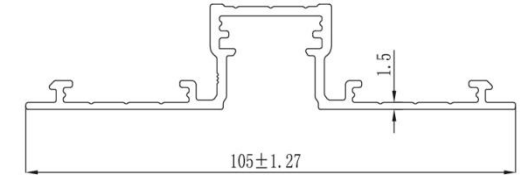

Dwg NO.	Thickness (mm)	Weight (kg/m)
SP15436-16	1.5	0.864

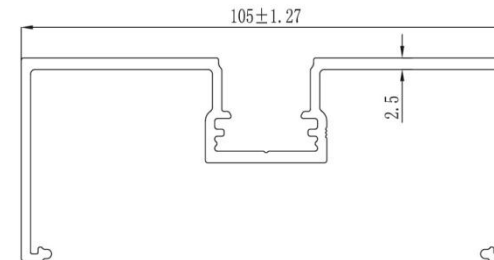

Dwg NO.	Thickness (mm)	Weight (kg/m)
SP15436-15	2.5	1.471

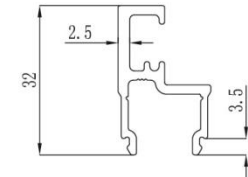

Dwg NO.	Thickness (mm)	Weight (kg/m)
SP15436-14	2.5	0.411



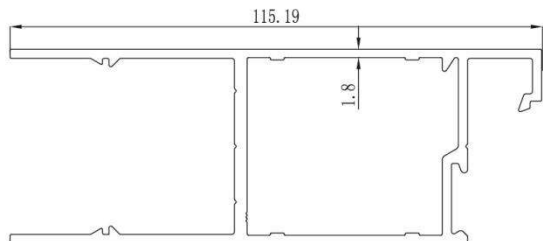

Dwg NO.	Thickness (mm)	Weight (kg/m)
SP15436-17	1.8	1.757

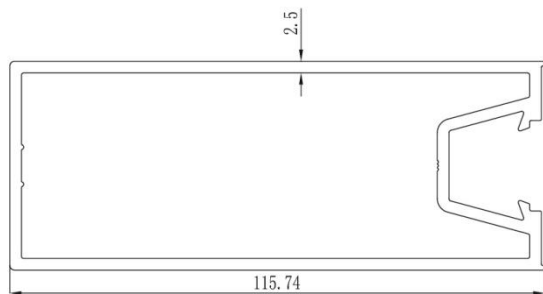

Dwg NO.	Thickness (mm)	Weight (kg/m)
SP15436-18	2.5	2.378

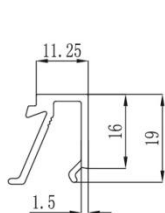

Dwg NO.	Thickness (mm)	Weight (kg/m)
SP15436-19	1.5	0.231

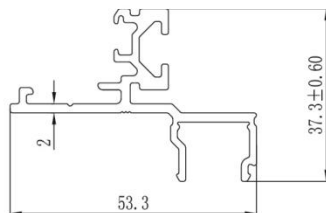

Dwg NO.	Thickness (mm)	Weight (kg/m)
SP15436-22	2.0	0.717



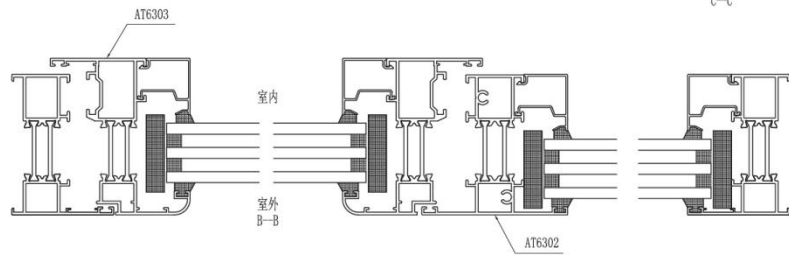
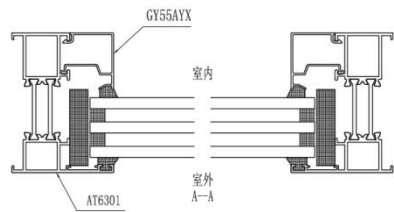
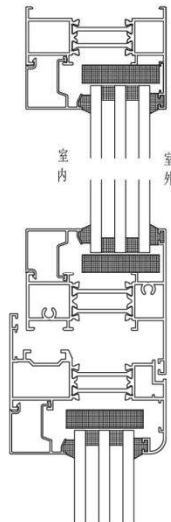
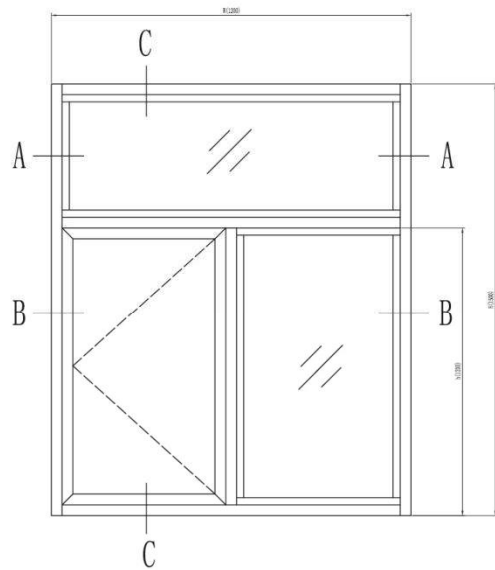

C-C

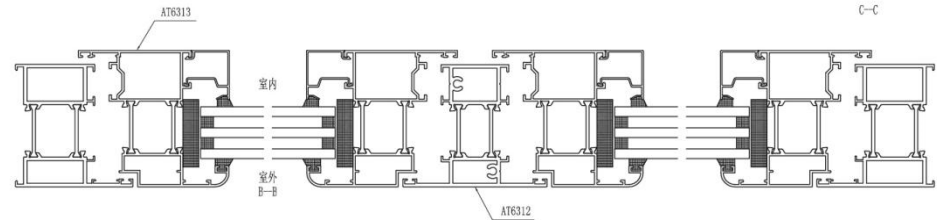
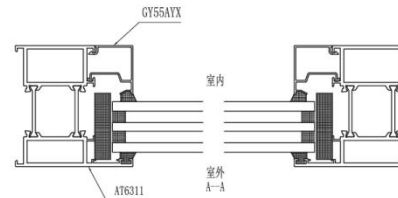
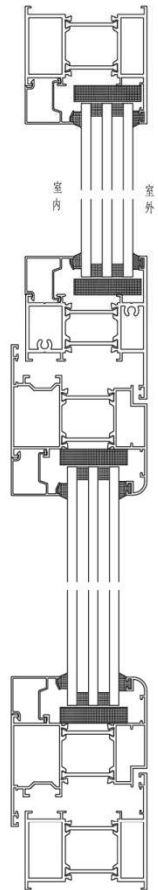
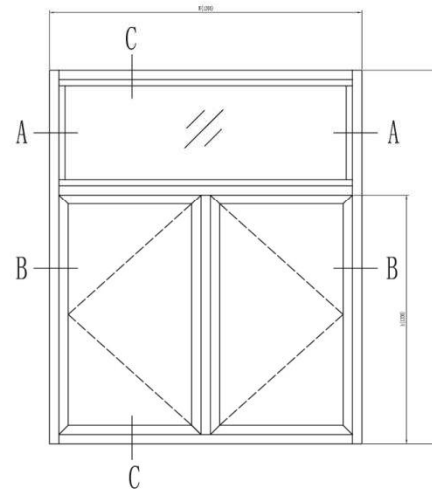

C-C

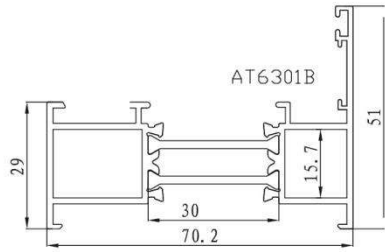

Dwg NO.	Thickness (mm)	Weight (kg/m)
AT6301	1.4	1.464

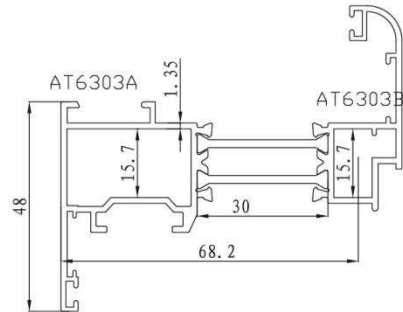

Dwg NO.	Thickness (mm)	Weight (kg/m)
AT6303	1.4	1.193

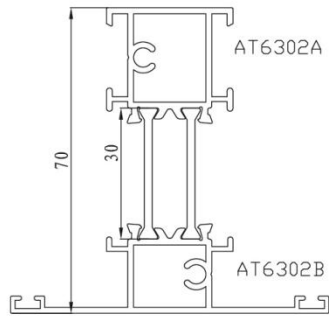

Dwg NO.	Thickness (mm)	Weight (kg/m)
AT6302	1.4	1.314

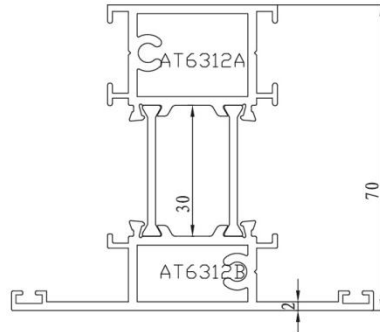

Dwg NO.	Thickness (mm)	Weight (kg/m)
AT6312	2.0	0.756

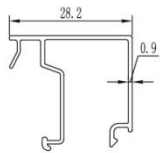

Dwg NO.	Thickness (mm)	Weight (kg/m)
GY55AYX	0.9	0.306

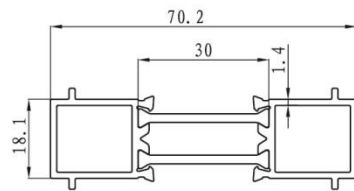

Dwg NO.	Thickness (mm)	Weight (kg/m)
GR55A205	1.4	0.306

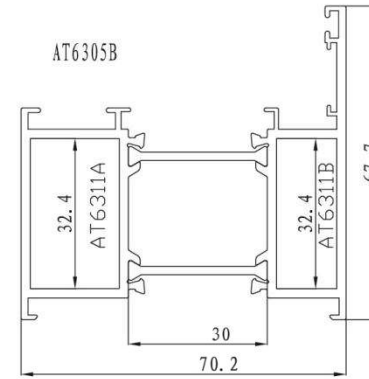

Dwg NO.	Thickness (mm)	Weight (kg/m)
AT6311	2.0	1.464

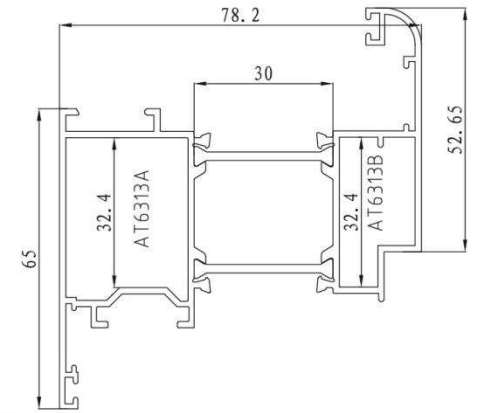

Dwg NO.	Thickness (mm)	Weight (kg/m)
AT6313	2.0	1.193

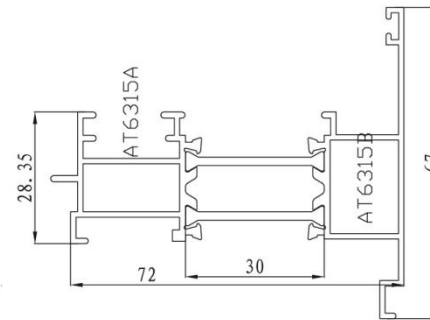

Dwg NO.	Thickness (mm)	Weight (kg/m)
AT6315	1.15	1.314

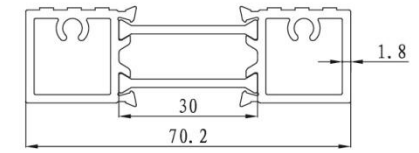

Dwg NO.	Thickness (mm)	Weight (kg/m)
AT55MK	1.8	0.756

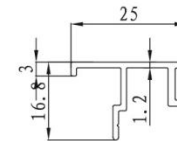

Dwg NO.	Thickness (mm)	Weight (kg/m)
AT63MF	1.2	0.306

Dwg NO.	Thickness (mm)	Weight (kg/m)





China Famous Brand  
www.staluminum.com



High Rise Window Series



China Famous Brand  
www.staluminum.com



High Rise Railing Series

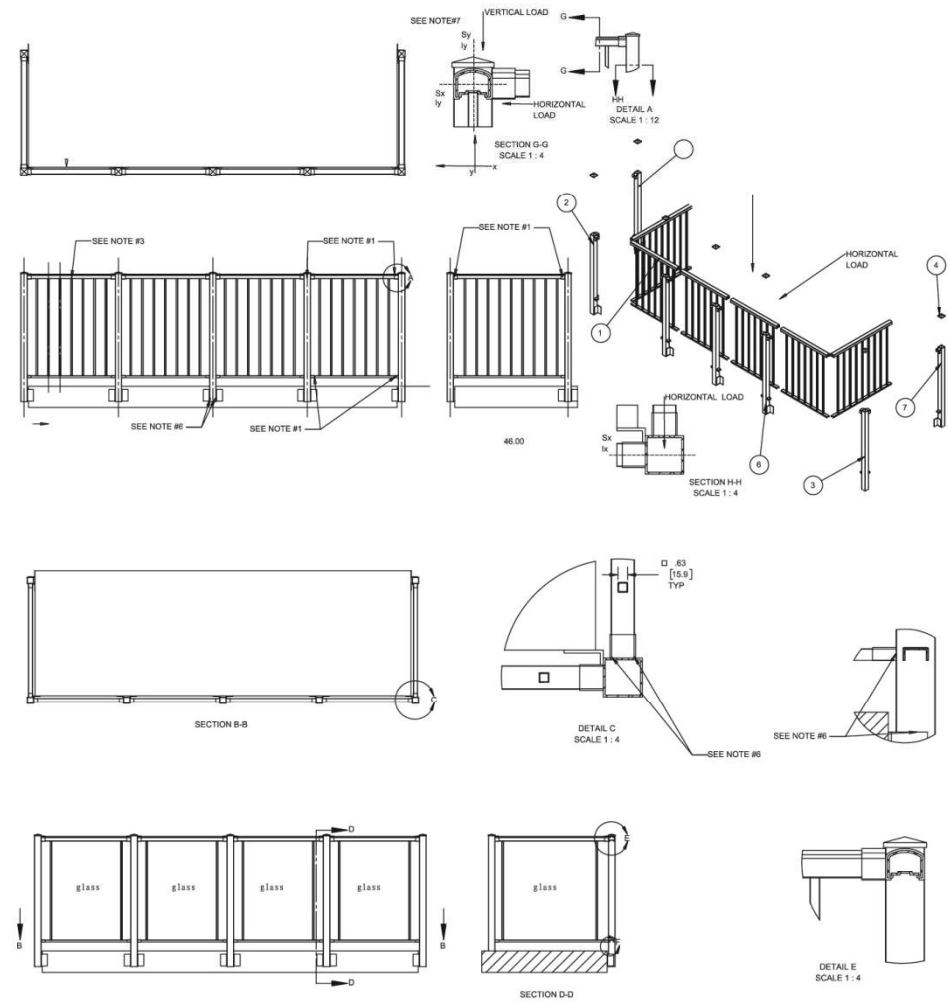

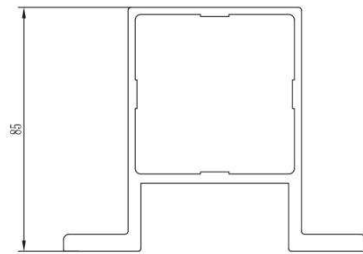
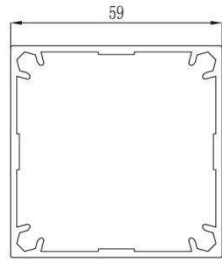

Dwg NO.	Thickness (mm)	Weight (kg/m)
FS01	1.7	1.31

Dwg NO.	Thickness (mm)	Weight (kg/m)
FS02	2.45	3.043

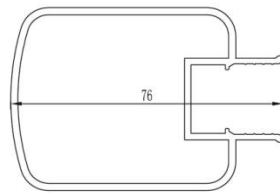
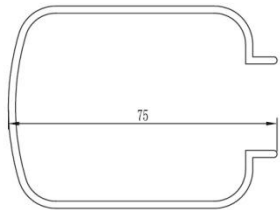

Dwg NO.	Thickness (mm)	Weight (kg/m)
FS03	2.0	1.129

Dwg NO.	Thickness (mm)	Weight (kg/m)
FS04	2.0	1.325

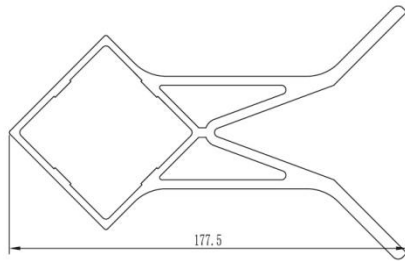

Dwg NO.	Thickness (mm)	Weight (kg/m)
FS05	3.0	6.504

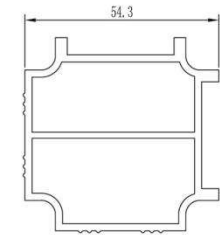
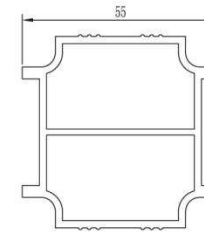

Dwg NO.	Thickness (mm)	Weight (kg/m)
FS06	2.0	1.464

Dwg NO.	Thickness (mm)	Weight (kg/m)
FS07	2.35	1.193

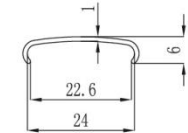
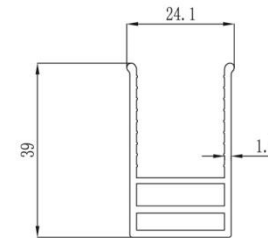

Dwg NO.	Thickness (mm)	Weight (kg/m)
FS08	1.5	0.562

Dwg NO.	Thickness (mm)	Weight (kg/m)
FS09	1.0	0.088

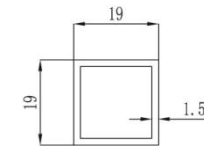
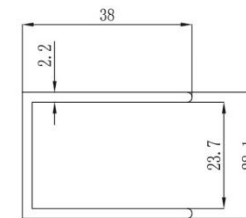

Dwg NO.	Thickness (mm)	Weight (kg/m)
FS10	2.2	0.59

Dwg NO.	Thickness (mm)	Weight (kg/m)
FS11	1.5	0.284

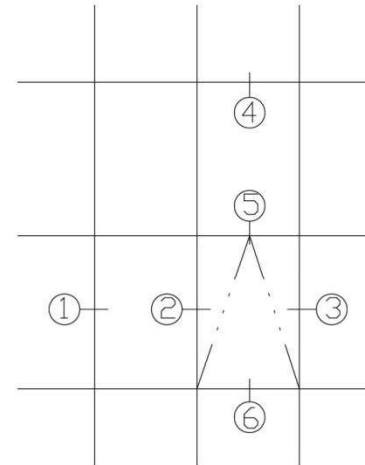

说明：更换立柱可组成不同系列幕墙

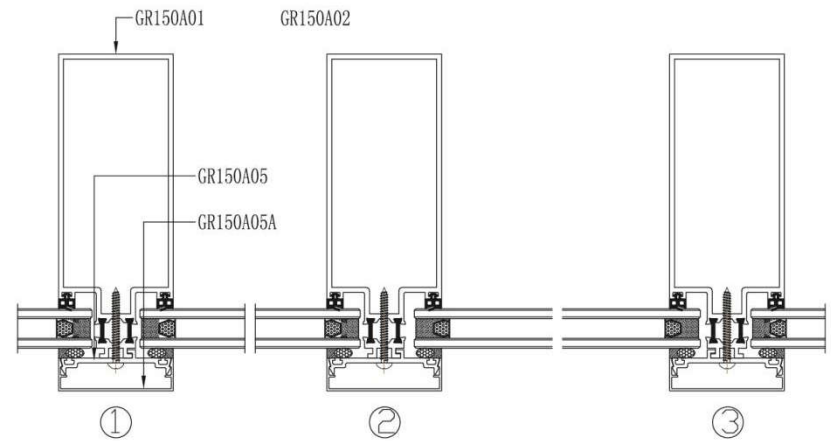
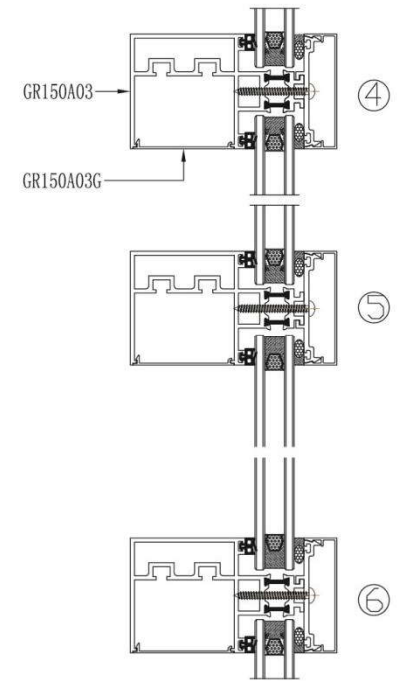



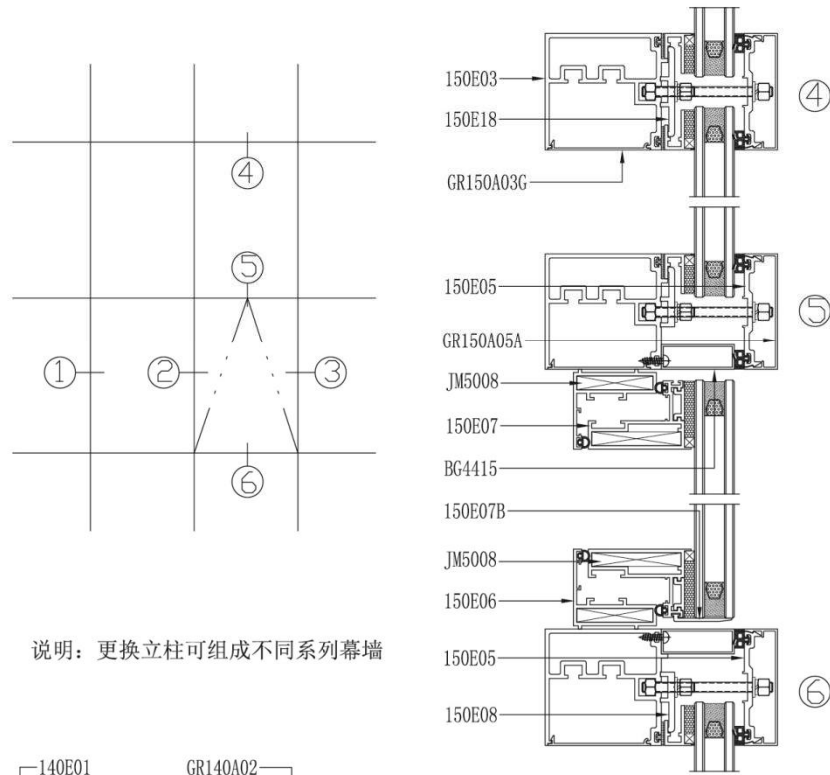

说明：更换立柱可组成不同系列幕墙

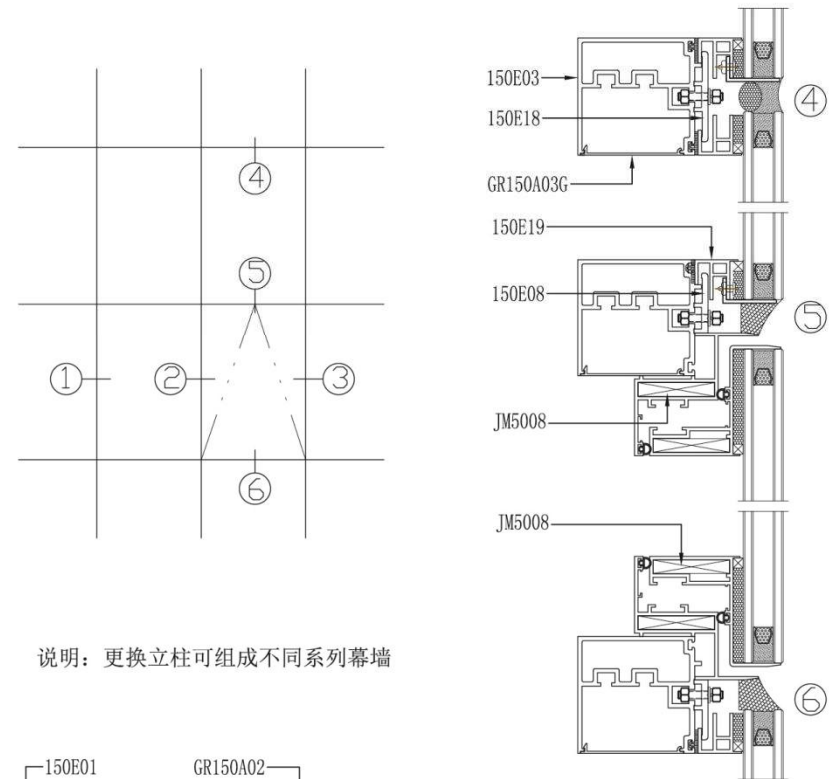
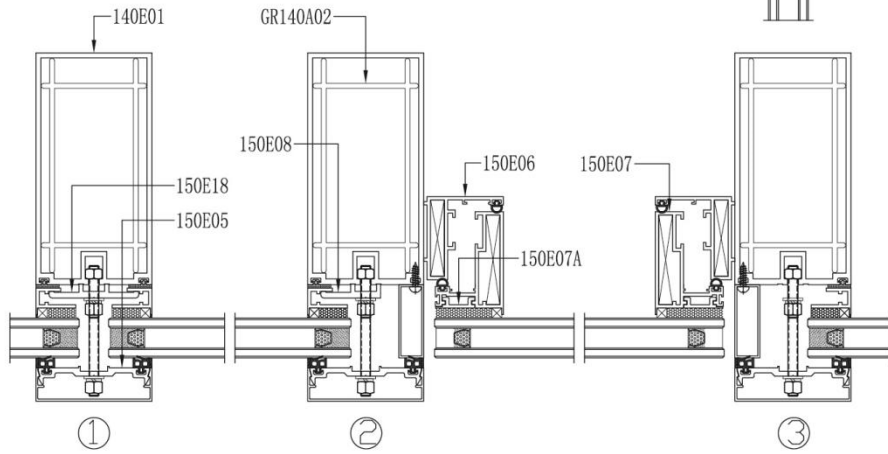

说明：更换立柱可组成不同系列幕墙

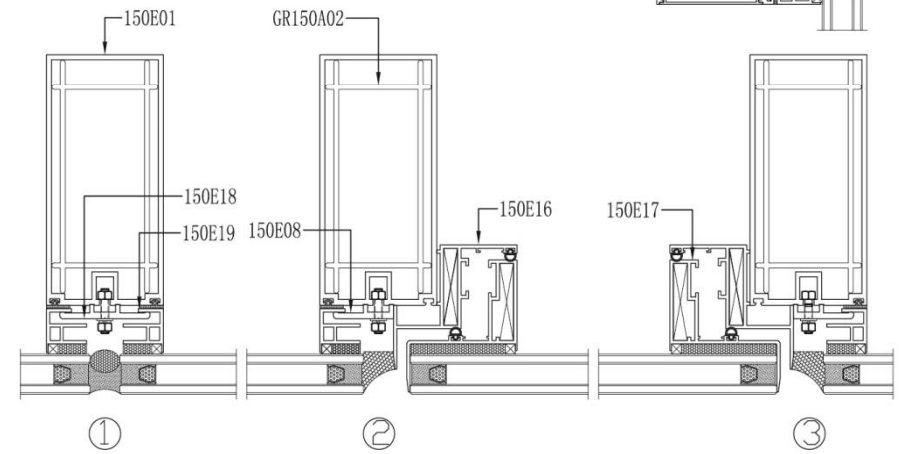

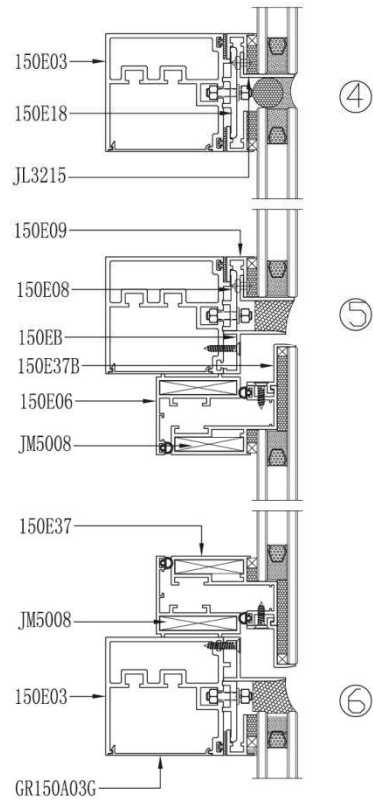
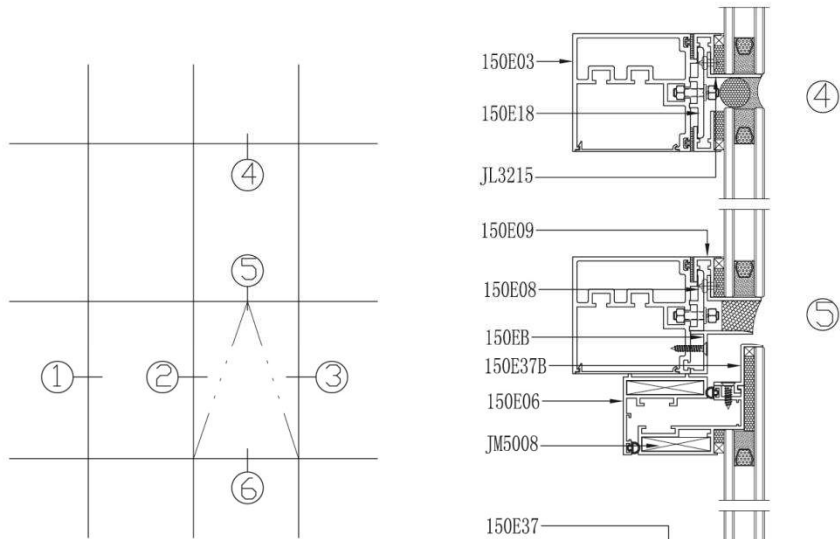

说明：更换立柱可组成不同系列幕墙

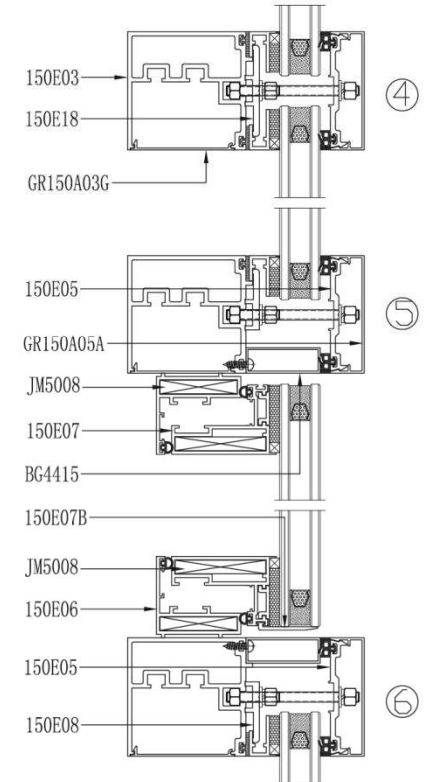
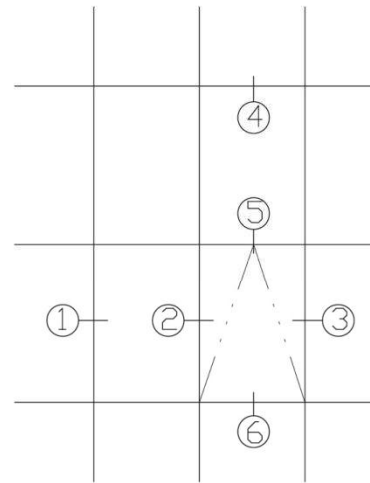
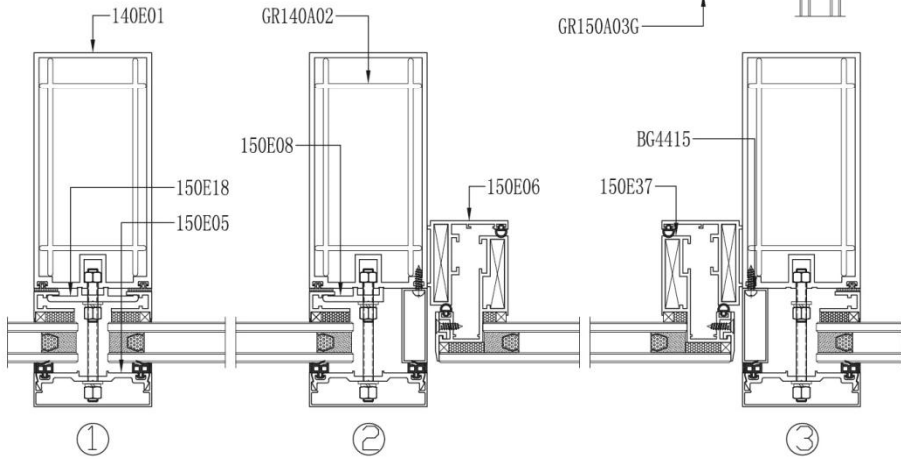

说明：更换立柱可组成不同系列幕墙

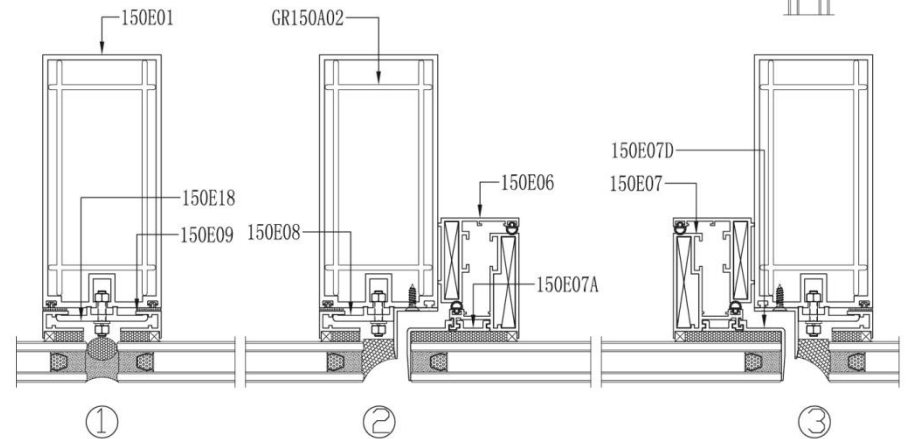

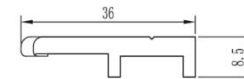
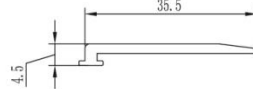
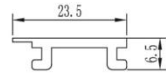
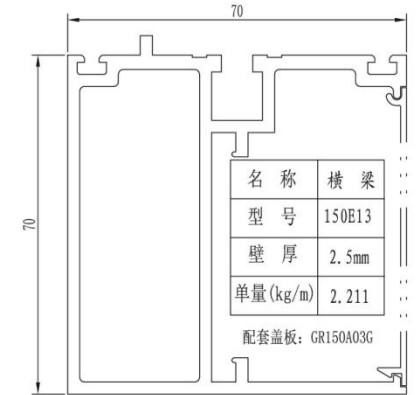
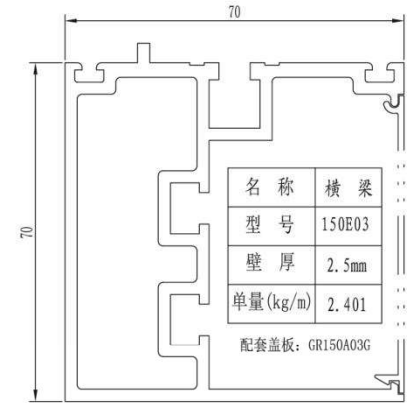
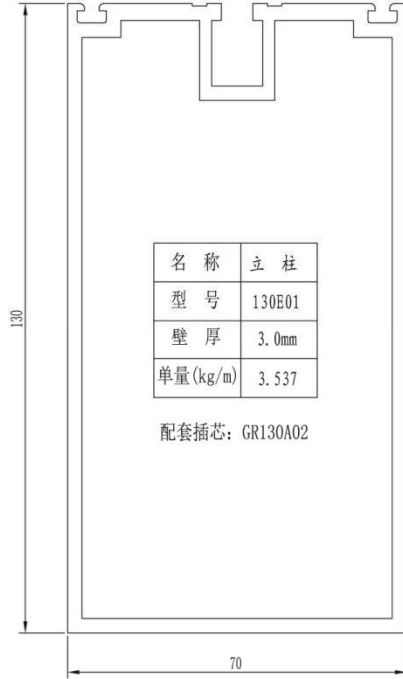
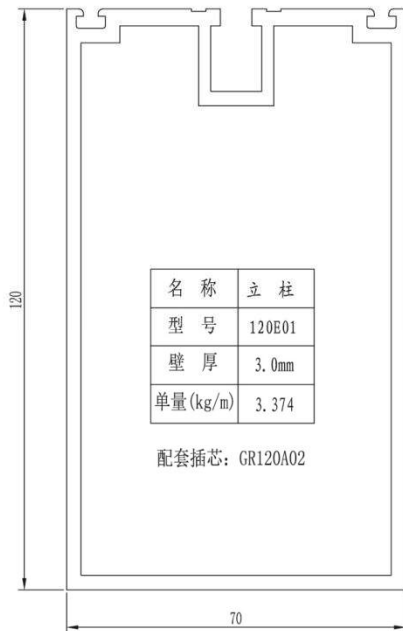

名称	型号	壁厚	单量(kg/m)
Profile	Dwg No.	Thickness	Theor. weight
扇料组件	150E07A	2.0mm	0.184

名称	型号	壁厚	单量(kg/m)
Profile	Dwg No.	Thickness	Theor. weight
开启扇组件	150E07B	2.0mm	0.205

名称	型号	壁厚	单量(kg/m)
Profile	Dwg No.	Thickness	Theor. weight
单压块	150E08	3.5mm	0.429

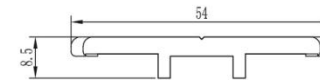
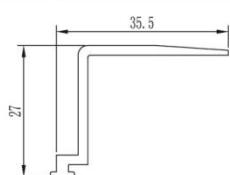
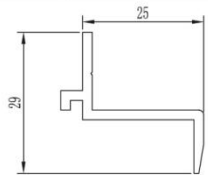

名称	型号	壁厚	单量(kg/m)
Profile	Dwg No.	Thickness	Theor. weight
开启扇组件	150E37B	2.0mm	0.309

名称	型号	壁厚	单量(kg/m)
Profile	Dwg No.	Thickness	Theor. weight
开启扇组件	150E07D	2.0mm	0.316

名称	型号	壁厚	单量(kg/m)
Profile	Dwg No.	Thickness	Theor. weight
双压块	150E18	3.5mm	0.601

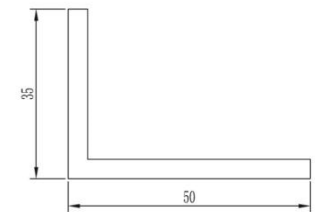

名称	型号	壁厚	单量(kg/m)
Profile	Dwg No.	Thickness	Theor. weight
角铝	JL5035	4.0mm	0.881



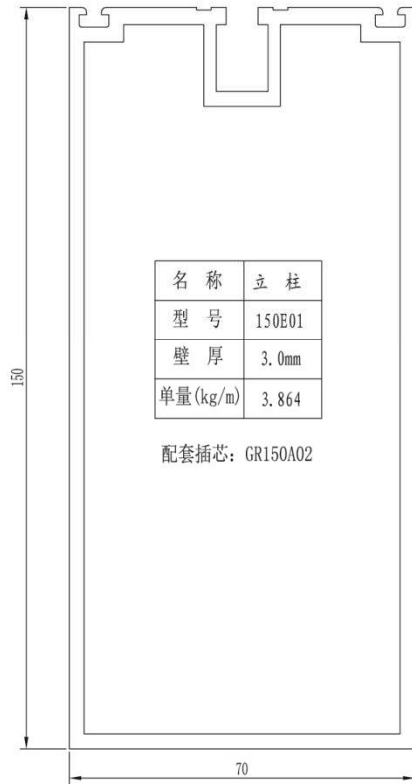

名称	立柱
型号	150E01
壁厚	3.0mm
单量(kg/m)	3.864

配套插芯: GR150A02

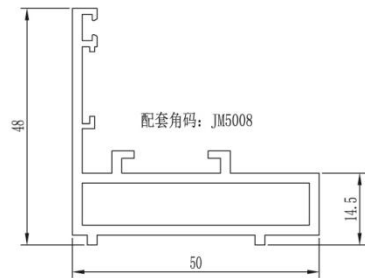

配套角码: JM5008

名称	型号	壁厚	单量(kg/m)
Profile	Dwg No.	Thickness	Theor. weight
开启框	150E06	2.0mm	0.949

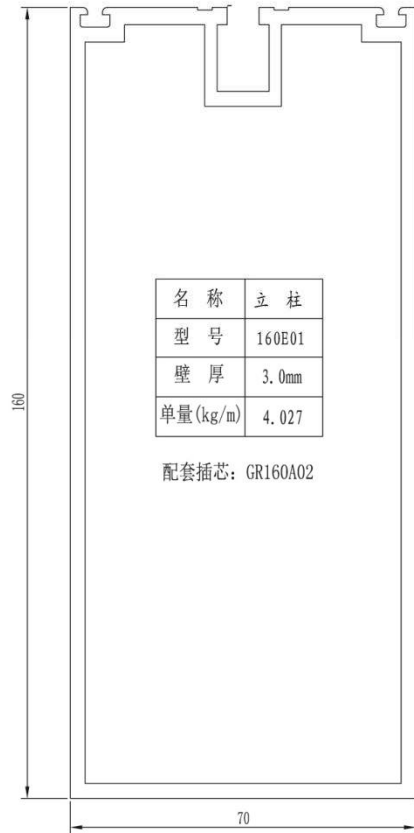

名称	立柱
型号	160E01
壁厚	3.0mm
单量(kg/m)	4.027

配套插芯: GR160A02

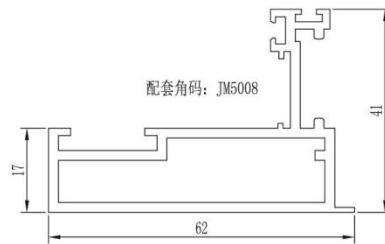

配套角码: JM5008

名称	型号	壁厚	单量(kg/m)
Profile	Dwg No.	Thickness	Theor. weight
开启扇	150E07	2.0mm	1.079

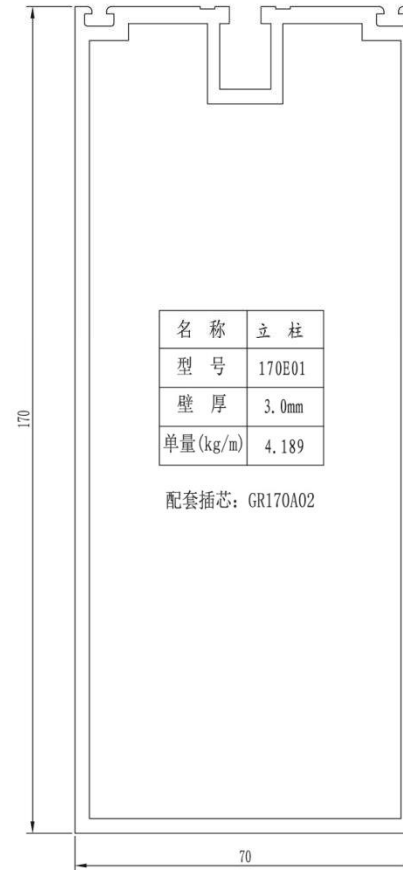

名称	立柱
型号	170E01
壁厚	3.0mm
单量(kg/m)	4.189

配套插芯: GR170A02

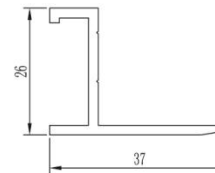

名称	型号	壁厚	单量(kg/m)
Profile	Dwg No.	Thickness	Theor. weight
上封边	150EB	2.0mm	0.372

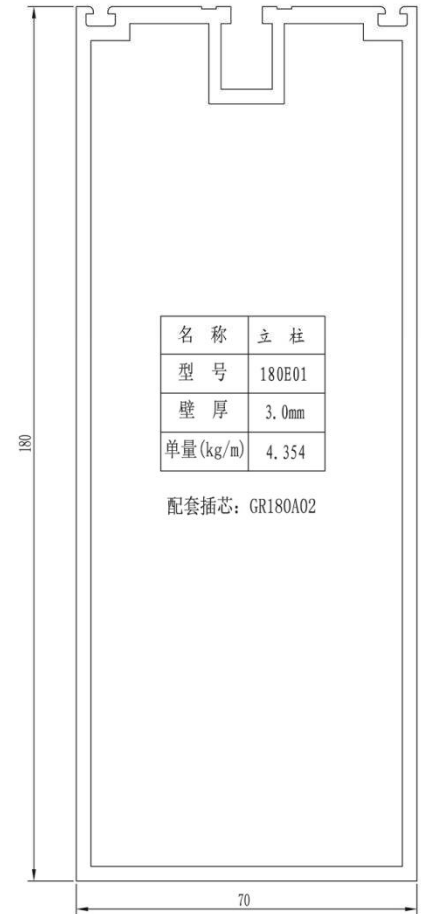

名称	立柱
型号	180E01
壁厚	3.0mm
单量(kg/m)	4.354

配套插芯: GR180A02

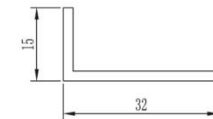

名称	型号	壁厚	单量(kg/m)
Profile	Dwg No.	Thickness	Theor. weight
角铝	JL3215	2.0mm	0.244



名称	立柱
型号	200E01
壁厚	3.0mm
单量(kg/m)	4.679

配套插芯: GR200A02

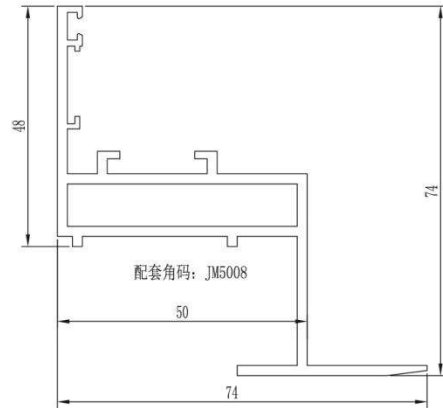

名称	型号	壁厚	单量(kg/m)
Profile	Dwg No.	Thickness	Theor. weight
开启扇	150E16	2.0mm	1.287

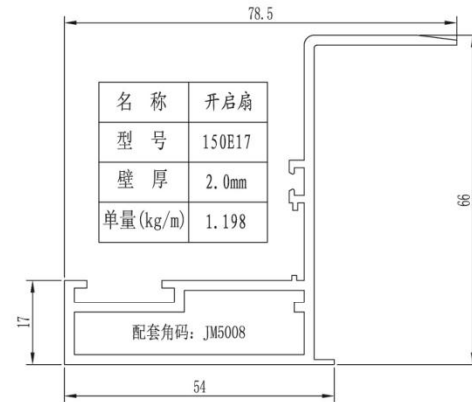

名称	开启扇
型号	150E17
壁厚	2.0mm
单量(kg/m)	1.198

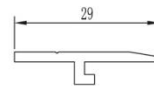

名称	型号	壁厚	单量(kg/m)
Profile	Dwg No.	Thickness	Theor. weight
开启扇组件	150E37A	2.0mm	0.185

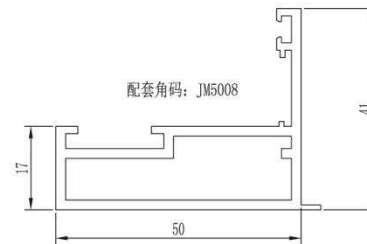

名称	型号	壁厚	单量(kg/m)
Profile	Dwg No.	Thickness	Theor. weight
开启扇	150E27	2.0mm	0.919

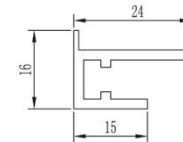

名称	型号	壁厚	单量(kg/m)
Profile	Dwg No.	Thickness	Theor. weight
玻璃托	150E09	2.0mm	0.283

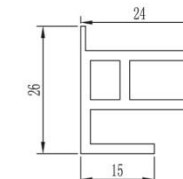

名称	型号	壁厚	单量(kg/m)
Profile	Dwg No.	Thickness	Theor. weight
玻璃托	150E19	2.0mm	0.481

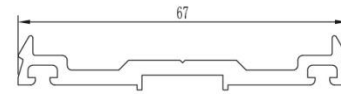

名称	型号	壁厚	单量(kg/m)
Profile	Dwg No.	Thickness	Theor. weight
玻璃夹	150E05	3.0mm	0.677

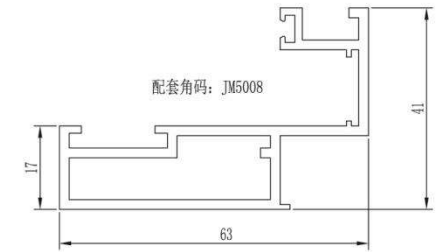

名称	型号	壁厚	单量(kg/m)
Profile	Dwg No.	Thickness	Theor. weight
开启扇	150E37	2.0mm	1.066

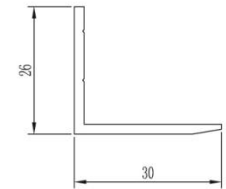

名称	型号	壁厚	单量(kg/m)
Profile	Dwg No.	Thickness	Theor. weight
上封边	150EA	2.0mm	0.285

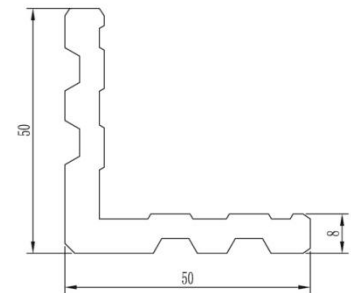

名称	型号	壁厚	单量(kg/m)
Profile	Dwg No.	Thickness	Theor. weight
角码	JM5008		1.633

